



Slim, High-density
LED Light Bar
Part#: 221301

Job Information <i>Fill out project details for this product below</i>			
Project		Location	
Contact		Date	
Product Number		Fixture Type	

Offering higher lumens, the only choice of linear LED lighting for installations with ultra-shallow spaces like cabinets, retail shelving and architecture highlights. With a 4 mm pitch, OmniStick Slim offers a visually linear line of light.



APPLICATIONS

- Shelves
- Cove Lighting
- Corner Lighting
- Displays

LIGHT TEMPERATURE

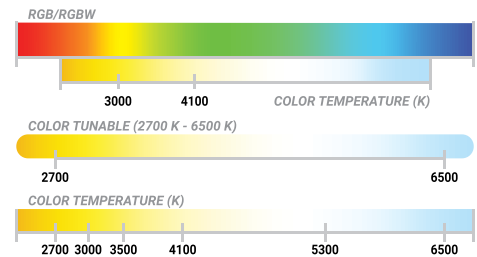

OVERVIEW

FRONT VIEW

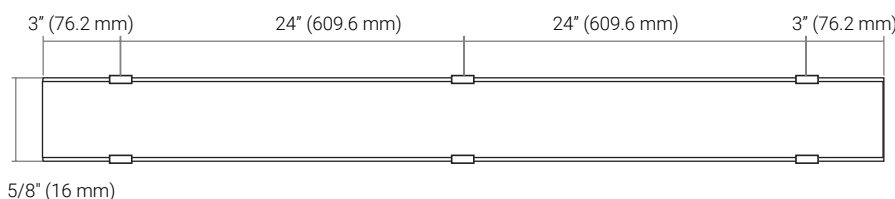

PROFILE VIEW

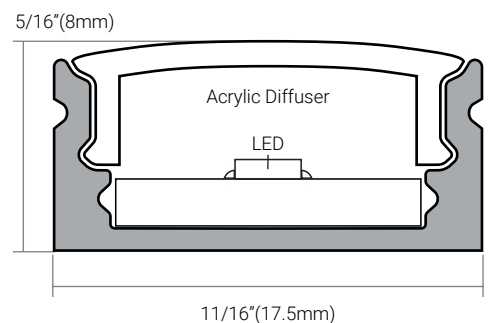



Slim, High-density
LED Light Bar
Part#: 221301

SPECIFICATIONS

PHYSICAL					
Part Number 221301	OmniLine*	OmniLine Plus	Tunable	RGB	RGBW
Series	LMS				
Chip	OmniChip				
Beam Angle	120°				
CRI	≥ 90				
Color Temperature	2700K, 3000K, 3500K, 4100K, 5300K, 6500K	2700K, 3000K, 3500K, 4100K, 5300K, 6500K	2700K-6500K	RGB	W(3000K), W(4100K)
LED Count/ft	36/ft	72/ft	48/ft	25/ft	29/ft
Lumens	175-197 lm/ft 2.4W 350-390lm/ft 4.4W	2.4W/ft - 180lm/ft 3.7W/ft - 326-360lm/ft	370-420 lm/ft	131 - 142 lm/ft	RGB: 12-50lm/ft W: 244 lm/ft
Operating Temperature	-30 °C (-22 °F) ~ +40 °C (+104 °F)				
Environment	Dry location only (indoor)				
Pitch Length	8.3 mm	4mm	12.5 mm	12 mm	10.3 mm
Cutable Length	12V: 3 LEDs - 1" 24V: 6 LEDs - 2"	7 LEDs 1.16"	12V: 3 LEDs - 1.8" 24V: 3 LEDs - 3.9"	24V: 6 LEDs - 2.8"	24V:12 LEDs - 4.9"
Width	5 m (16')/spool - 4mm	4mm	5 m (16')/spool - 6mm	5 m (16')/spool - 6mm	5 m (16')/spool - 6mm
Maximum Run	12V - 8.25 ft 24V- 10 ft	24V-6.6 ft	12V - 8.25 ft 24V - 10 ft	12V - 5 ft 24V- 6.6 ft	24V - 10 ft
ELECTRICAL					
	OmniLine*	OmniLine Plus	Tunable	RGB	RGBW
Input Voltage	12V DC 24V DC	24V DC	12V DC 24V DC	12V DC 24V DC	24V DC
Power Consumption	2.4W/ft 4.4W/ft	2.4 W/ft (Low wattage) 3.7 W/ft (Standard)	5.5 W/ft (Tunable) using Controllers (4 W/ft per each channel, 8W/ft Max)	4.4W/ft (Maxi)	4.9W/ft (Maxi)
Wiring	Ex-10 cable - UL E336579 • PS-2 cable - UL E336579 • PS-4 cable - UL E336579 • PS-6 cable - UL E338684				
Connector	Quick Connecting Wires (sold separately) 3000K/4100K/5300K/6500K : Quick connector on one end, 2.1/5.5mm barrel plug on the other end, 20 AWG 2 wires wrapped with jacket in color black in 6" length. 3000K/4100K/5300K/6500K : Quick connector on one end, 2-pin male plug connector on the other end, 20AWG, wires in white/grey in 6" length.				
Certification	UL listed (E346146)				



Slim, High-density
LED Light Bar
Part#: 221301

OVERVIEW

MOUNTING CLIP OPTIONS

SCREW-IN MOUNTING CLIPS



ADJUSTABLE MOUNTING CLIPS

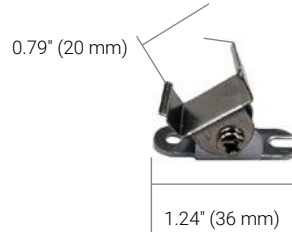

CORNER ANGLE MOUNTING CLIPS



WIRING

- Determine your system components, including a Class 2 power adapter, as well as optional dimmer and controller (if required). Use only UL certified power adapters with the power output that coordinates with your input voltage. Do not apply 24 VDC to 12 VDC Light Bar.

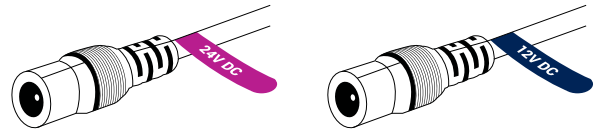

WIRING WITH PLUG-IN POWER ADAPTORS:

- Use a plug-in adaptor to connect the Light Bar to your power source.



WIRING WITH HARDWIRE POWER ADAPTORS:

- Turn off power to your system at the main breaker;
- Install your system components. Refer to wiring guidelines for each component to build your system;
- Check connections and turn on power at the main breaker.

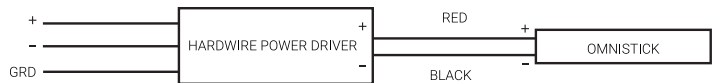

WIRING RGB/W

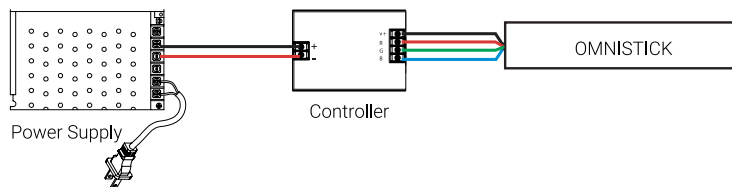

WIRING TUNABLE





Slim, High-density
LED Light Bar
Part#: 221301

ACCESSORIES AND OPTIONS

POWER ADAPTORS OPTIONS



Plug-in (Class 2)

950003	12V	60W
950021	24V	24W
950024	24V	90W
950035	24V	96W
950036	12V	60W
950036	24V	60W

Hardwire

951005	12V	60W
951009	12V	150W
951012	24V	60W
950037	12V	60W
950037	24V	60W
950038	24V	96W
950039	24V	150W

5 in 1 Dimming Driver

951003-12-060	12V	60W
951004-24-096	24V	96W
951006-24-192	24V	2x96W

LED Power Driver (Class 2)

950003-12-060	12V	60W
---------------	-----	-----

* Other power options available on request

Dimmable Driver

950007	12V	60W
951010	12V	150W

RGBW Dimmable Driver

950035	RF RGBW Driver	24VDC
950036	RF RGBW Remote Control	

CONTROLLER OPTIONS



DMX Decoder

970032	12-36VDC	4x (96-288)W
970033	12-24VDC	5x (96-192)W

Inline Dimmer with Remote

970007	12V	72W
970007	24V	144W

Rotatory Style Dimmer

970002	5V	40W
970002	12V	96W
970002	24V	192W

Inline Plug and Play Dimmer

970014	12V	48W
970014	24V	96W

LED Dimming Module

970001	12V	60W
970001	24V	98W

CCT Controller

970025	12V/24V	Max. 60W
--------	---------	----------

DMX Wall Controller

970041	CCT Tunable	12-24VDC
970042	RGBW	12-24VDC

RF CCT Driver

951029	24V	90W
--------	-----	-----

RF CCT Wall Controller

970043	12-24VDC	
--------	----------	--

Power Repeater

970037	12-36VDC	4x (60-180)W
--------	----------	--------------



Slim, High-density
LED Light Bar
Part#: 221301

ACCESSORIES AND OPTIONS

CONNECTOR OPTIONS

DC jack 5'

80008	White
80006	Black

DC jack 10' (W)

80009	White
80007	Black

2 pin connector cable 5'

980048	White
980049	Black

Omnify Connector Hub

980047	White
--------	-------

WIRING OPTIONS

Option 1	EX-10 Cable
Option 2	PS-2 Cable
Option 3	PS-4 Cable
Option 4	PS-6 Cable

MOUNTING OPTIONS

Option 1	Screw-in Mounting Clips
Option 2	Adjustable Mounting Clips
Option 3	Corner Angle Mounting Clips



Slim, High-density
LED Light Bar
Part#: 221301

ORDER INFORMATION

LMS Series

Product #	Size	Color Temperature		Voltage	Wattage
221004	z-y: Custom Size	270-2700 K	000 Tunable(2700 K - 6500 K)	12-12V DC 24-24V DC	2.4 2.4 W/ft (Low Wattage)
		300-3000 K	900 RGB		3.7 3.7 W/ft (OmniLine Plus)
		350-3500 K	950 RGBW (3000K)		4.4 4.4 W/ft (Standard)
		410-4100 K	951 RGBW (4100K)		4.9 4.9 W/ft (RGBW)
		530-5300 K	100 Static red		5.5 5.5 W/ft (Tunable)
		650-6500 K	110 Static green		
			120 Static blue		
Connectors	Wiring	Mounting	-	-	-
80008 DC jack 5' White 80006 DC jack 5' Black 80009 DC jack 10' White 80007 DC jack 10' Black 980048 2 Pin Connector 5' cable White 980049 2 pin Connector 5' cable Black 980047 Omnify Connector Hub	1: Ex-10 cable 2: PS-2 cable 3: PS-4 cable 4: PS-6 cable	1 Screw-In Mounting Clips 2 Adjustable Mounting Clips 3 Corner Angle Mounting Clips			

EXAMPLE

221301-11-530-24-2.4-80008-1-1

The specification number immediately above can be deconstructed as follows:

- OmniStick Slim Light Bar; Dimensions(CL)-11"; Color Temperature-5300K; Voltage-24V; Wattage-2.4 W/ft; DC Jack 5' White(80008); Ex-10 cable (1); Screw-in Mounting Clips (1)